

HSF RoHS

**SPECIFICATIONS
PERFORMANCE**

Electical Rating: AC/DC 50V 0.5A
 Insulation Resistance: 500MΩ
 Withstang Volt: 200V AC/minute
 Opratng Temperature: -40°C to +105°C
 Material
 Contact: Phosphor Bronze
 Plating: Au or Sn Over Ni
 Housing: LCP
 Max.Processing Temp: 260°C±5° 5S

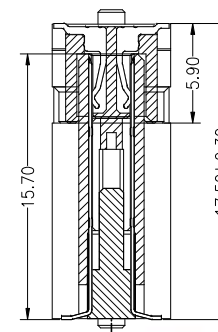
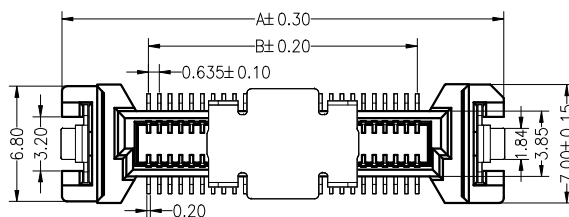

MATING DRAWING(REF)

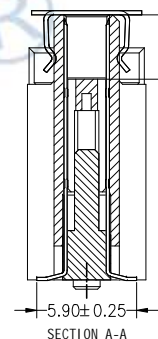
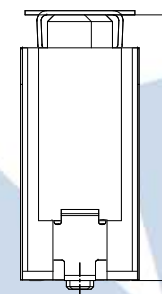
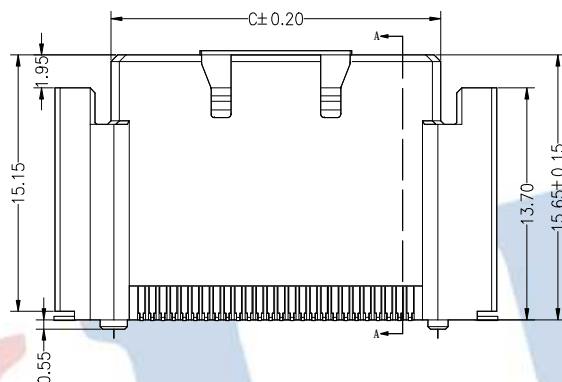

Ordering Information

3722 F XXX 157 XX X X 0X

F=Female
 M=Male
 No.of pins
 30,40,
 50,52P
 Plastic Hight
 157=15.7mm
 Contact Plating
 G0:Gold Flash
 G1:3U" Gold
 G2:5U" Gold
 G3:10U" Gold
 G4:15U" Gold
 S0:1.5U" Gold/Tin
 S1:3U" Gold/Tin
 Insulator
 Material
 Option
 D=BK-PA46
 E=BK-PA9T
 F=BK-LCP
 Packing
 T:Tube
 R:Reel

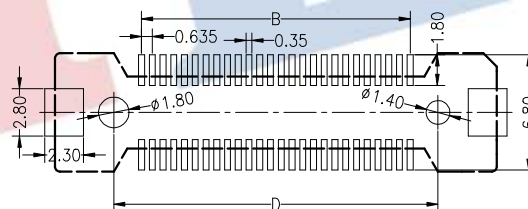
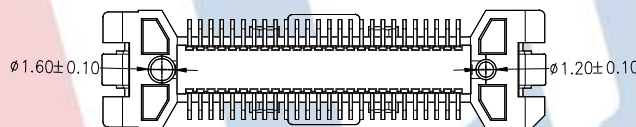

P.C.B Layout

No Of Pins	Dimensions (mm)			
	A	B	C	D
30	19.12	8.89	12.52	12.18
40	22.29	12.07	15.69	15.35
50	25.47	15.24	18.87	18.53
52	26.10	15.88	19.50	19.16

A	A0	2022.12.17	NEW DRAWING	OPERATION	DRAW	Jelly Feng	2022.12.17	SCALE	FIT	JILN ® 深圳市锦凌电子有限公司 SHENZHEN JINLING ELECTRONICS CO.,LTD Tel: 86-755-2997-5806/5802 Fax: 86-755-2997-5992	
	REV	DATE	MODIFICATION DESCRIPTION	CHANGE	X.X	±0.30	CHECK	UNIT	mm		
					X.XX	±0.20	APPROVE	SIZE	A4		
					X.XXX	±0.10		SHEET	1/1		
				Angle	±3°			PROJ.		PART NO.	3722FXXX157XXXX0X
				DIM	TOL					TITLE:	0.635mm BTB NPin H15.7 Female (PLC专用)